

























Back cover design variants

Products	Left pump	Right pump	Hydraulic motor
310.12 210.12 310.2.28 (View A)			
			
210.12 310.12 (View B)			
210.12 310.12 (View C)			
310.2.28 (View B)			
310.2.28 (Vista C)			
310.3.56 310.3.112 310.3.160 (View D)			
310.3.160 (View D)			
Hydraulic motors 310.12 210.12 (View A)			

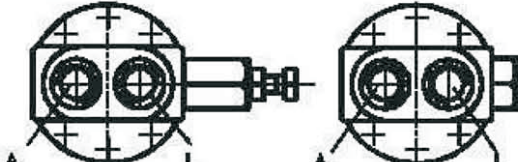

In the motor operating mode, working fluid delivered from hydraulic system through openings in the cover and through a groove in the distributor enters the cylinder block where it sets the pistons in motion.

The pistons transfer the force to a spherical joint.

Because the shaft axis and cylinder block axis are at an angle, the force acting on the joint is resolved into an axial and a tangential component.

The axial load is taken up by bearings while the tangential one develops a torque at the hydraulic motor shaft.

This shaft torque is directly proportional to the motor displacement (V) and pressure difference (ΔP), its value is limited by the safety valve.

The rotational speed (n) is direct proportional to working fluid supply and inversely proportional to the displacement.

Technical data of hydraulic motors

Parameter	Value															
	310.12 210.12	310.2.28	310.3.45	310...56	310.3.80	310...112	310.3.160	310.3.250								
Displacement (rated), cm ³	11,6	28	45	56	80	112	160	250								
Rotational speed, s ⁻¹ (rpm)	0,83 (50)															
- minimal																
- rated									40,0 (2400)	33,33 (2000)	30 (1800)	30,0 (1800)	25,0 (1500)	20,0 (1200)		16,67 (1000)
- maximal	100,0 (6000)	79,0 (4750)	62,5 (3750)	62,5 (3750)	55,8 (3350)	50,0 (3000)	44,0 (2650)	41,7 (2500)								
Output pressure, MPa	20															
- maximal																
Input pressure, MPa	20															
- rated																
- maximal	32				35											
Maximal drainage pressure, MPa	0,1				0,2											
Rated pressure difference, MPa	20															
Rated flow rate, dm ³ /s (l/min)	0,49 (29)	0,98 (59)	1,42 (85)	1,77 (106)	2,11 (126)	2,36 (142)	3,38 (203)	4,40 (264)								
Torque (rated), N·m	35	84	135	168	240	336	480	748								
Rated power (effective), kW	9	18	25	32	37,6	42	60	78								
Hydromechanical efficiency	0,96															
Overall efficiency									0,91							
Weight, kg	4	9	17	17	19,2	29	45	65								



In the pump operating mode, the shaft is set in rotation by the engine. Pistons mounted in the cylinder block turn on the cylinder block axis and reciprocate at the same time, with the piston sucking working fluid in one half revolution and pumping it into hydraulic system in another half revolution.

The output pressure is determined by working member load and limited by hydraulic system safety valve.

The delivery rate is determined by rotational speed of the pump shaft and pump displacement.

Technical data of pumps

Parameter	Value							
	210.12 310.12	310.2.28	310.3.45	310...56	310.3.80	310...112	310.3.160	310.3.250
Displacement (rated) cm ³	11,6	28	45	56	80	112	160	250
Rotational speed, s ⁻¹ (rpm)	6,7(400)							
- minimal	6,7(400)							
- rated	40 (2400)	30 (1800)	25 (1500)	25 (1500)	20,0 (1200)	20 (1200)	16,67 (1000)	
- maximal								
- at minimal input pressure	66,7 (4000)	50 (3000)	50 (3000)	41,7 (2500)	37,3 (2240)	33,3 (2000)	29,1 (1750)	25 (1500)
- at input pressure of 0,2 MPa, no less than	100,0 (6000)	79 (4750)	62,5 (3750)	62,5 (3750)	55,8 (3350)	50,0 (3000)	44,0 (2650)	41,7 (2500)
Delivery rate, dm ³ /s (l/min)								
- rated	0,44 (26)	0,8 (48)	1,07 (64)	1,33 (80)	1,52 (91,2)	2,13 (128)	3,04 (182)	3,96 (238)
Input pressure, MPa								
- minimal	0,08							
Output pressure, MPa								
- rated	20							
- maximal	35							
Rated power (consumed), kW	10	17	23	29	33	46	66	85
Volumetric efficiency	0,95							
Overall efficiency	0,91							
Weight, kg	4	9	17	17	19,2	29	45	65



Mounting dimensions
310.3.56,
210.12, 310.12
310.2.28, 310.3.45

310.3.45, 310.2.56,

310.3.80, 310.2.112, 310.3.112
310.3.160, 310.3.250

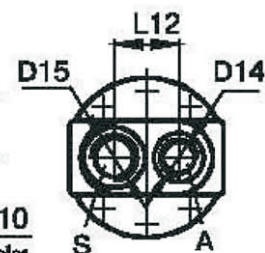
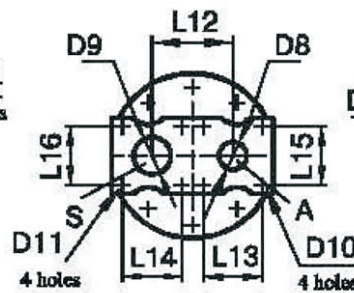
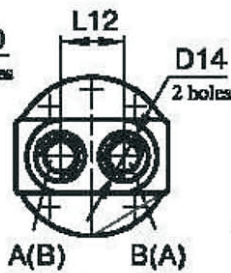
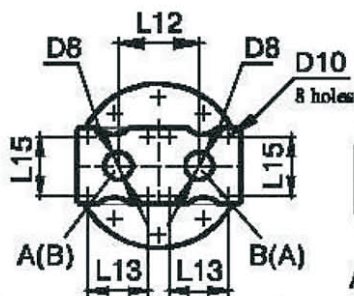
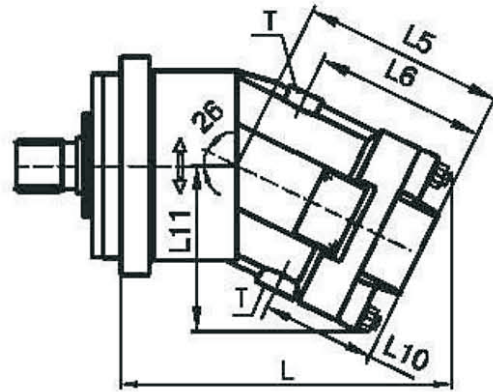
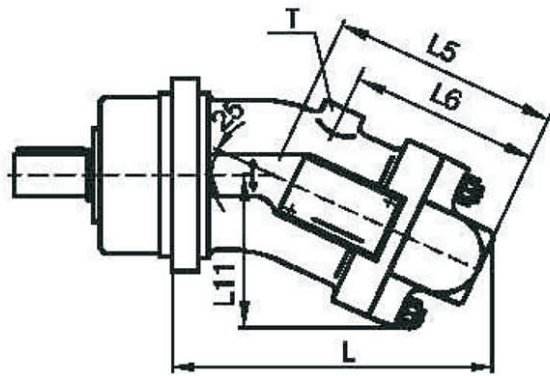

Dimension	210.12 / 310.12	310.2.28	310.3.45	310.2.56 310.3.56	310.3.80	310.2.112 310.3.112	310.3.160	310.3.250
D8			22	22	22	28	32	32
D9			30	30	30	38	42	62
D10			M10	M10	M10	M12	M14	M16
D11			M10	M10	M10	M12	M12	M16
D14	M22x1, 5	M27x2						
D15	M27x2	M33x2						
L	160 / 192	196	241	245	275	290	320	367
L5	112	147	153	153	166	177	210	251,2
L6	92	122	128	128		150	190	
L10			90	90	88	100	118	
L11	81	99	110	120	135	145	165	191
L12	36	50	67	67	70	82	99	102
L13			48	48	48	60	66,7	75
L14			48	48	48	60	69,9	75
L15			48	48	48	60	31,8	75
L16			48	48	48	60	35,7	75

Notes: 1- Threaded holes for operation and drainage lines are made according to GOST 25065-90

2 – See the other dimensions in the section “General information”.



Pump 310.3.56.00.68 with block of flushing and check safety valves.

The valve block ensures:

- protection of the hydraulic drive from high pressure;
- replacement of working fluid in a closed system by cooled and cleaned one using a booster pump.

The L nipple is connected with the tank.

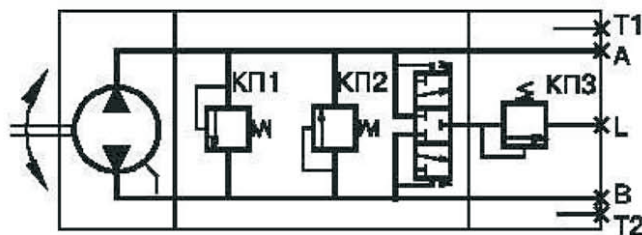
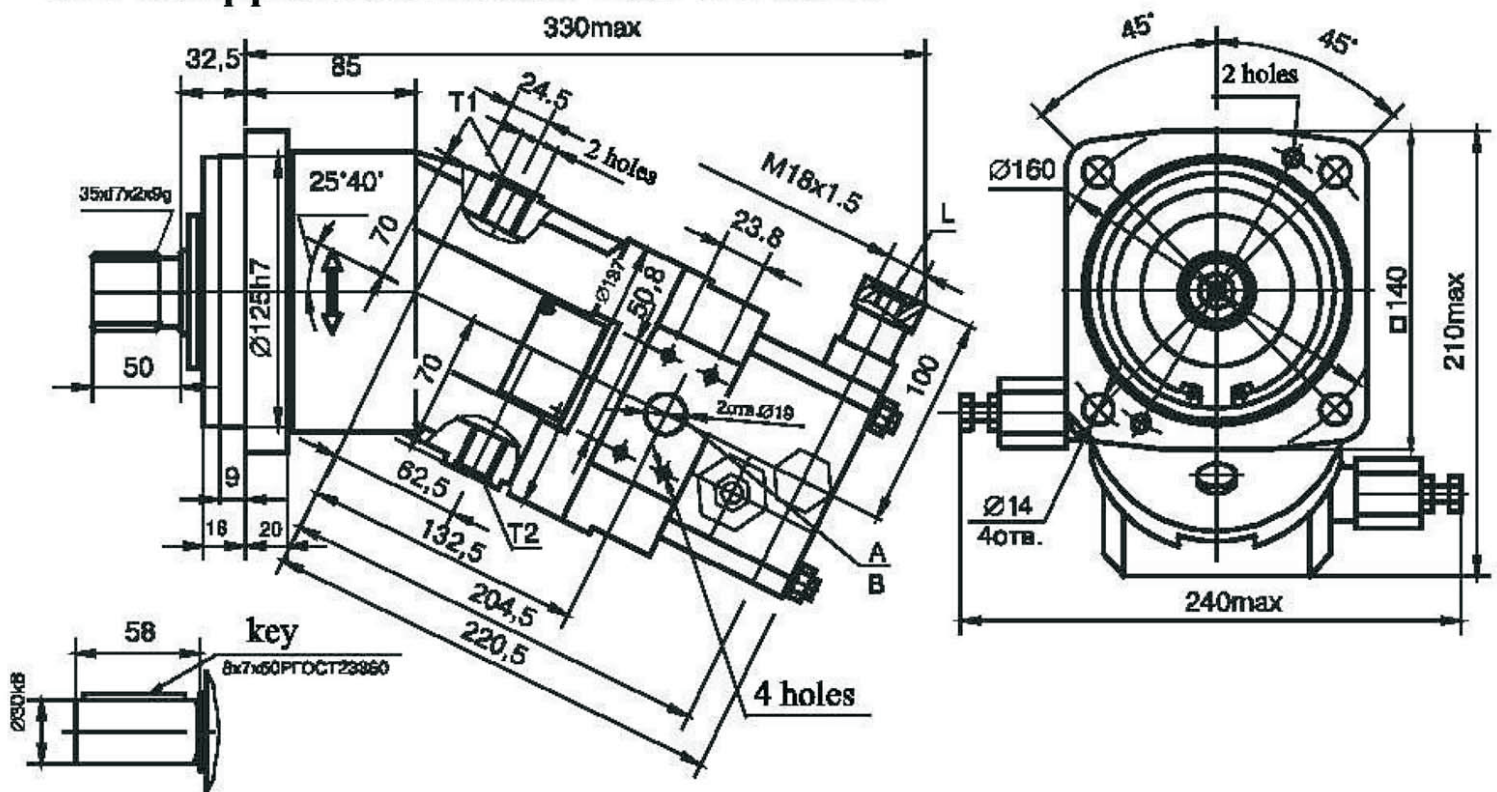

Valve adjustment:

КП 1 and КП 2 20 MPa

КП 3 1,2; 1,4; 1,6 and 1,8 Mpa

See the other dimensions in the section “General information”.